

# SP3 CCT1 1350



-  Lista de Peças
-  Lista de Piezas
-  List of Pieces

maclinea





2014 - 2015

# 🇧🇷 Gr. Base 3 grupos – 17726

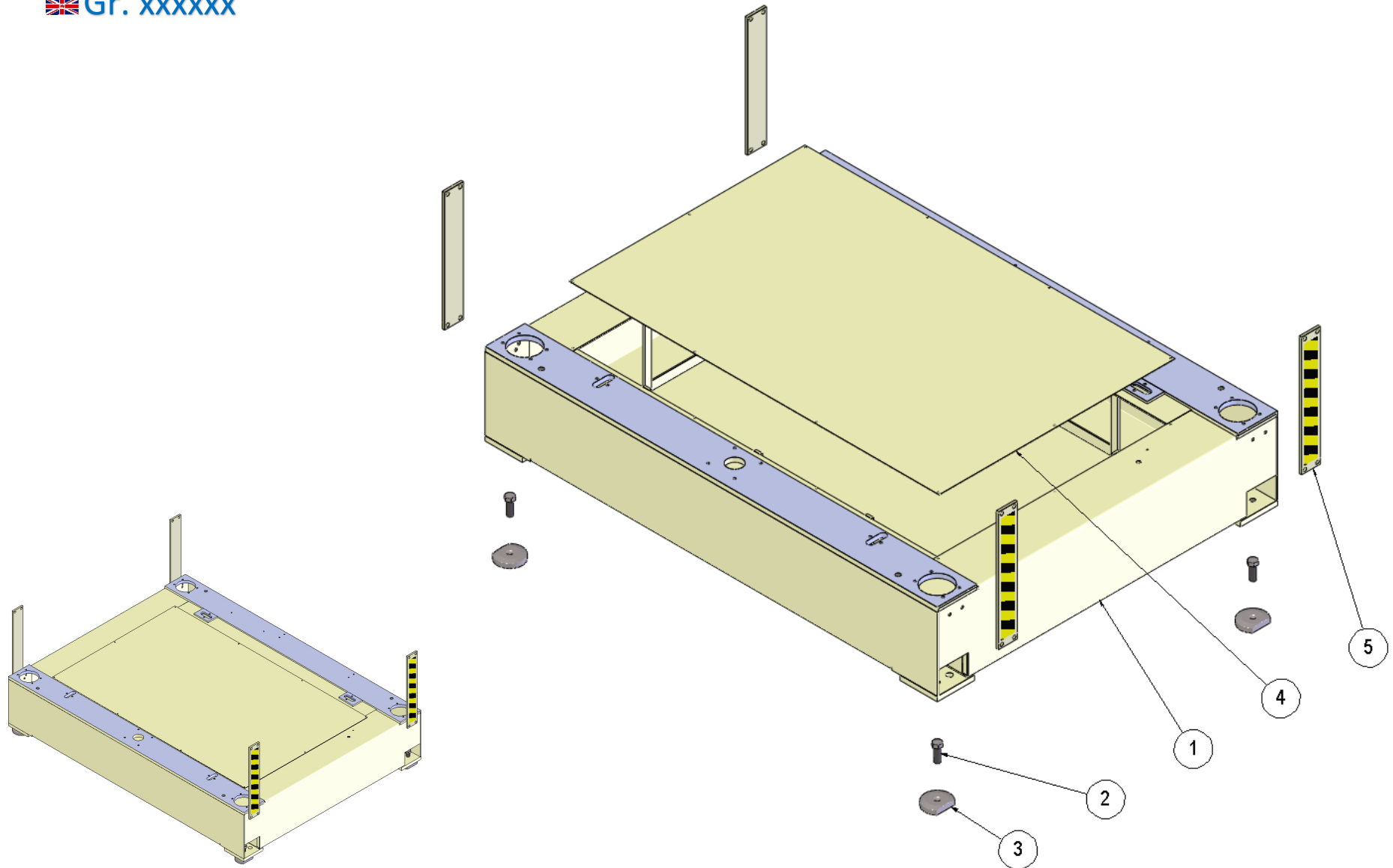
🇪🇸 Gr. xxxxxx

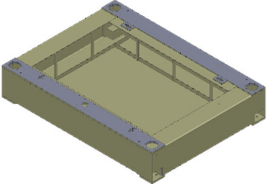
🇬🇧 Gr. xxxxxx

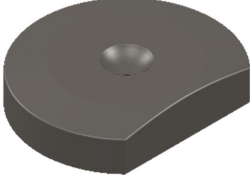
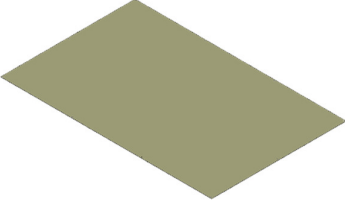





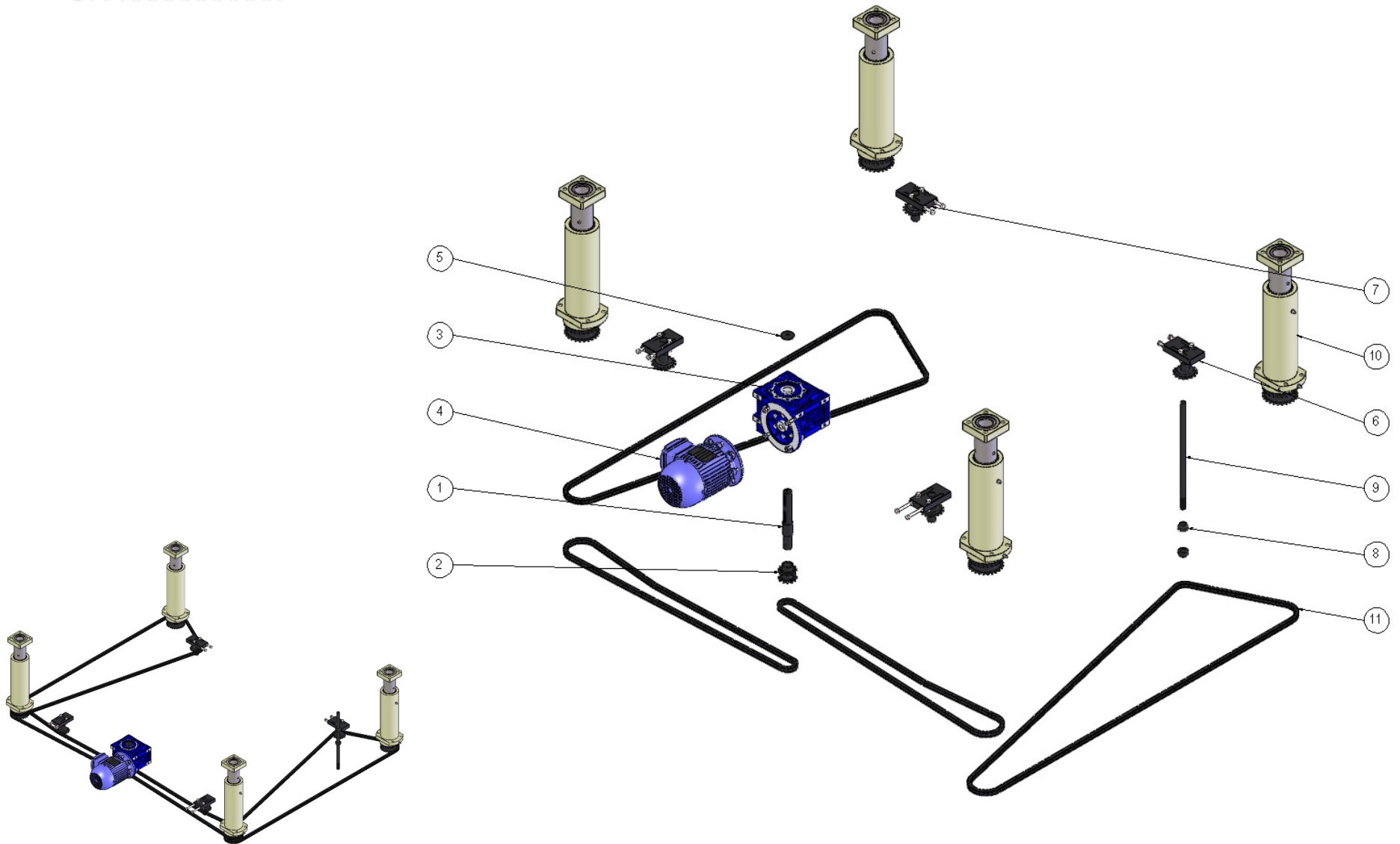

01	17728 (1X)	02	9343 (4X)	03	11321 (4X)	04	17730 (1X)	05	11476 (4X)
									

# 🇧🇷 Gr. Sobe-Desce – 11320

🇪🇸 Gr. xxxxxxxxxxx

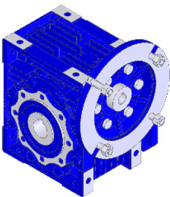
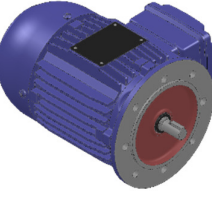
🇬🇧 Gr. xxxxxxxxxxx

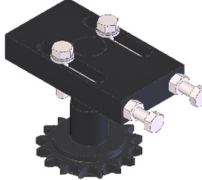
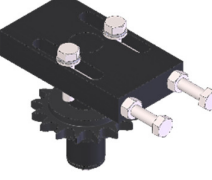
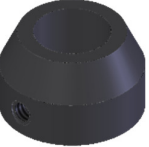

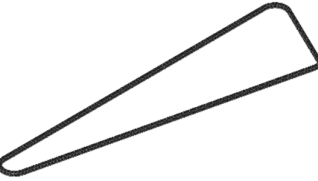
01	9357 (1X)	02	9356 (1X)	03	18115 (1X)	04	6598 (1X)	05	9467 (1X)
									
06	83566 (2X)	07	83566 (2X)	08	26195 (2X)	09	9363 (1X)	10	7707 (4X)
									
11	4672 (10m)								
									

# 🇧🇷 Sc. Esticador – 83566

🇪🇸 Sc. xxxxxxxxxxxxxx

🇬🇧 Ss. xxxxxxxxxxxxxx

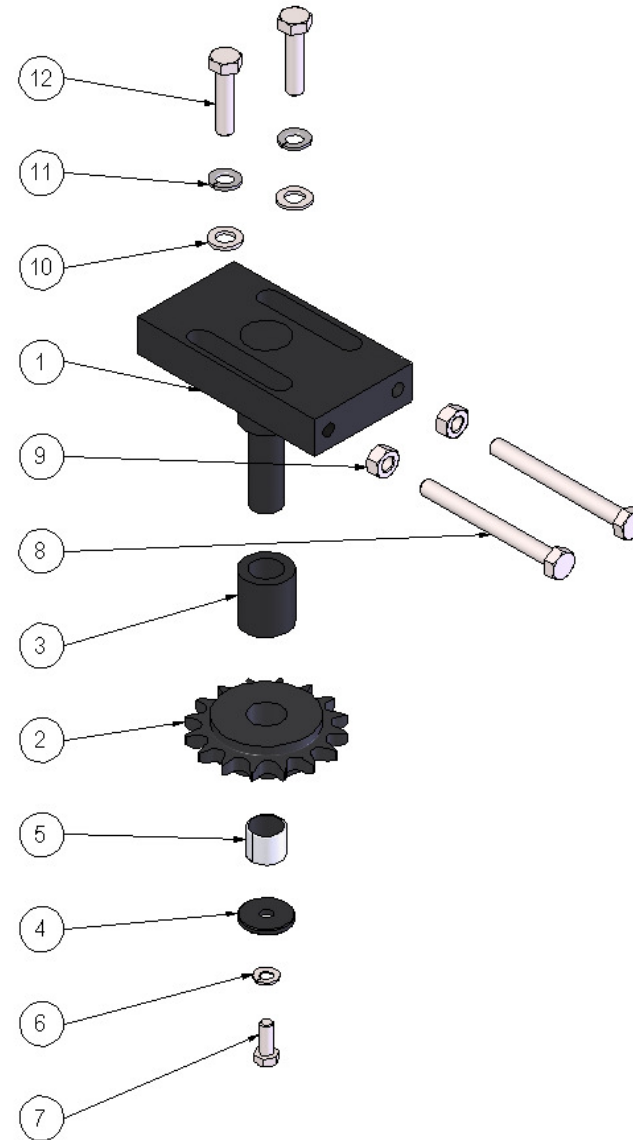
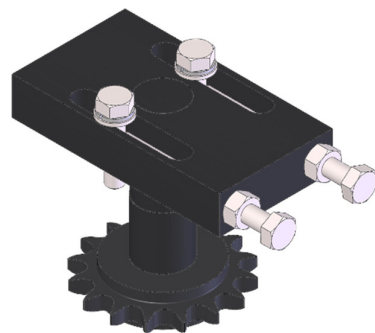

01	9358 (1X)	02	9359 (1X)	03	9360 (1X)	04	9646 (1X)	05	5724 (1X)
									
06	6243 (1X)	07	7087 (1X)	08	3299 (2X)	09	96 (2X)	10	98 (2X)
									
11	99 (2X)	12	1544 (2X)						
									





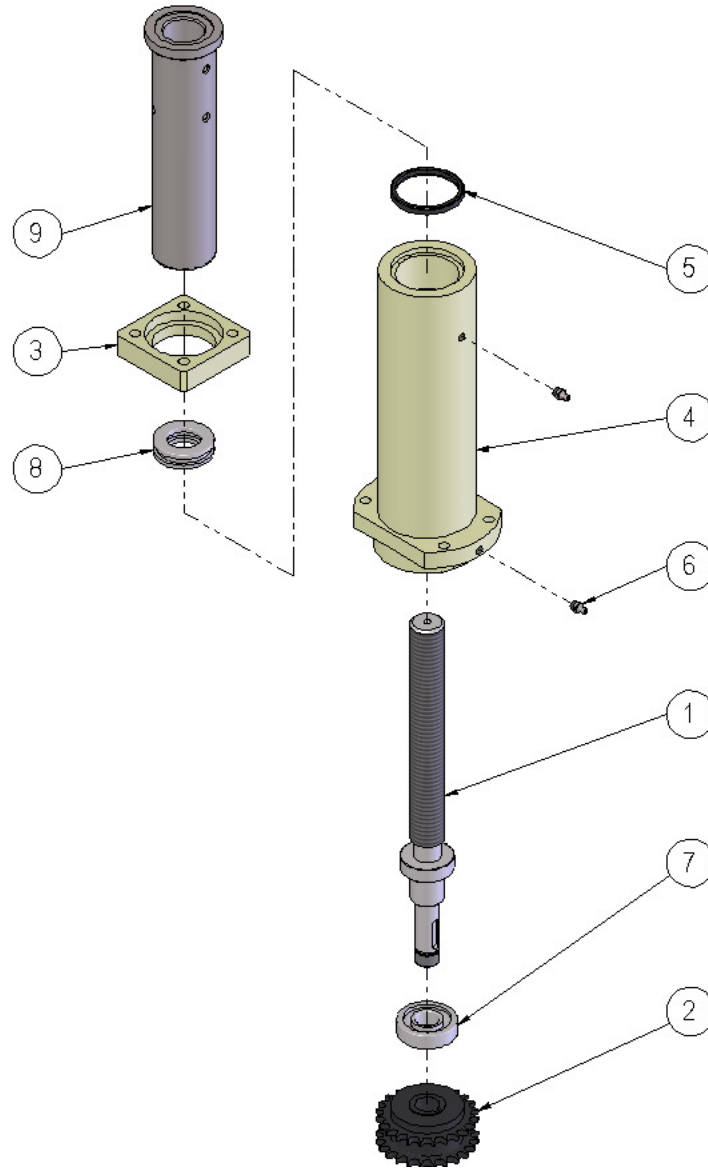

# 🇧🇷 Sc. Coluna Sobe-Desce – 7707

🇪🇸 Sc. xxxxxxxxxxxx

🇬🇧 Ss. xxxxxxxxxxxx

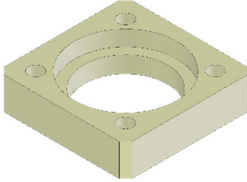
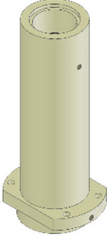

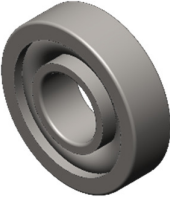
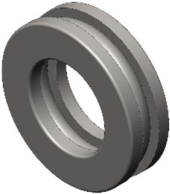







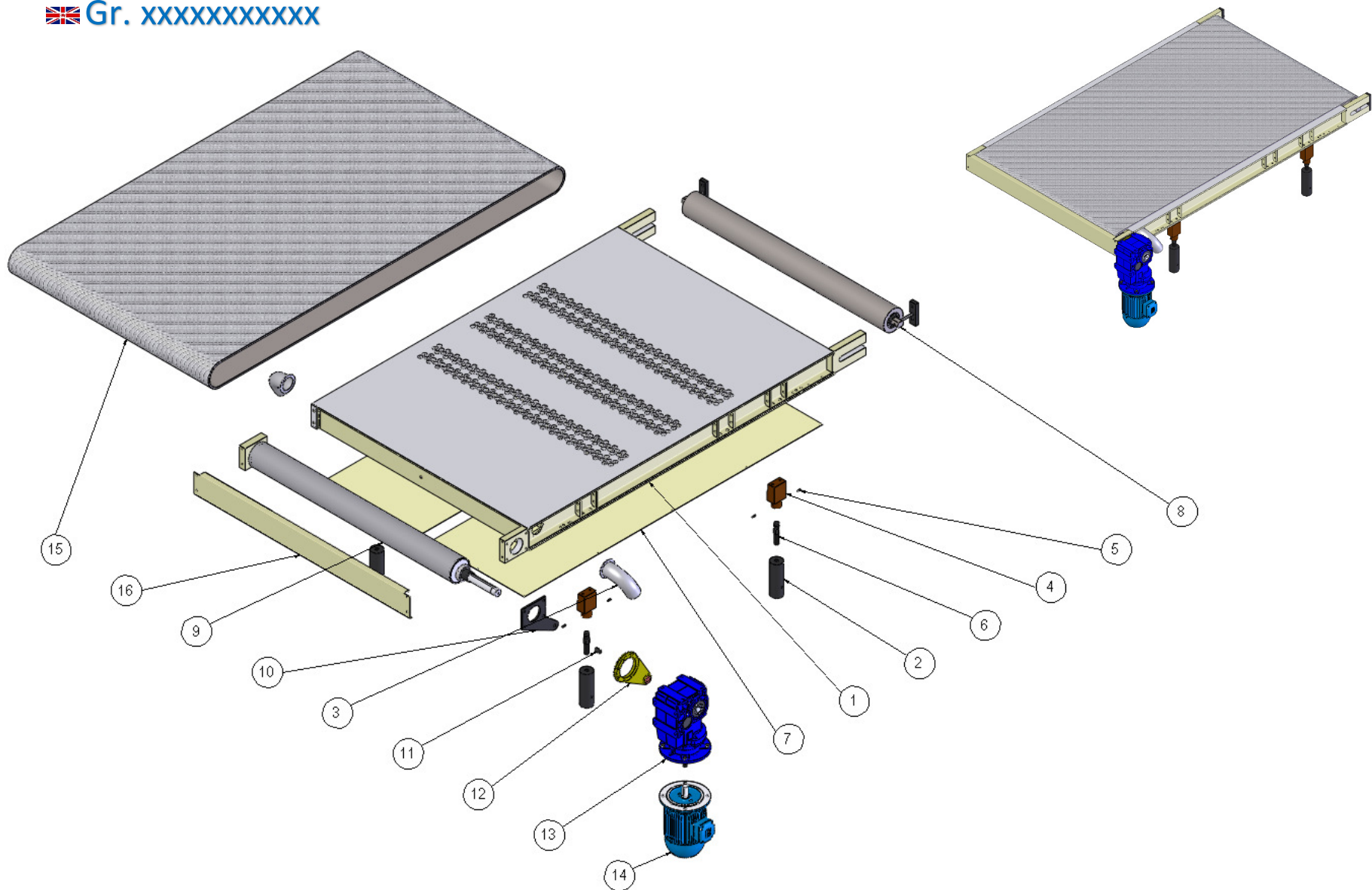

01	9365 (1X)	02	9366 (1X)	03	9367 (1X)	04	9368 (1X)	05	7304 (1X)
									
06	67261 (2X)	07	7229 (1X)	08	5024 (1X)	09	9369 (1X)		
									

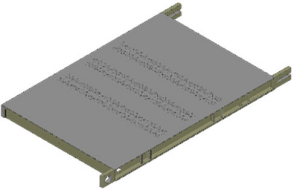
# 🇧🇷 Gr. Mesa 3 grupos – 11326

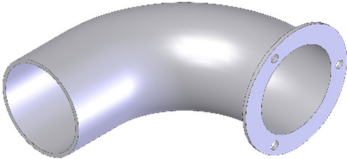
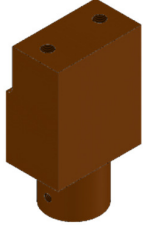
🇪🇸 Gr. xxxxxxxxxxxx

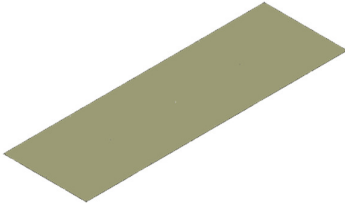
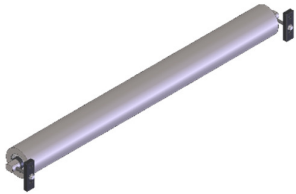
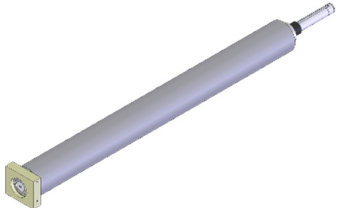
🇬🇧 Gr. xxxxxxxxxxxx



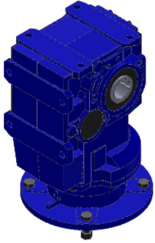
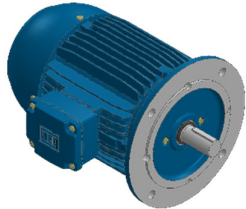
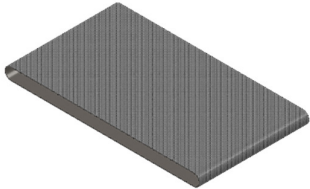
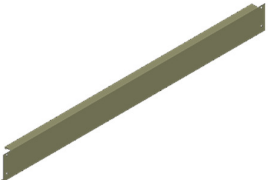



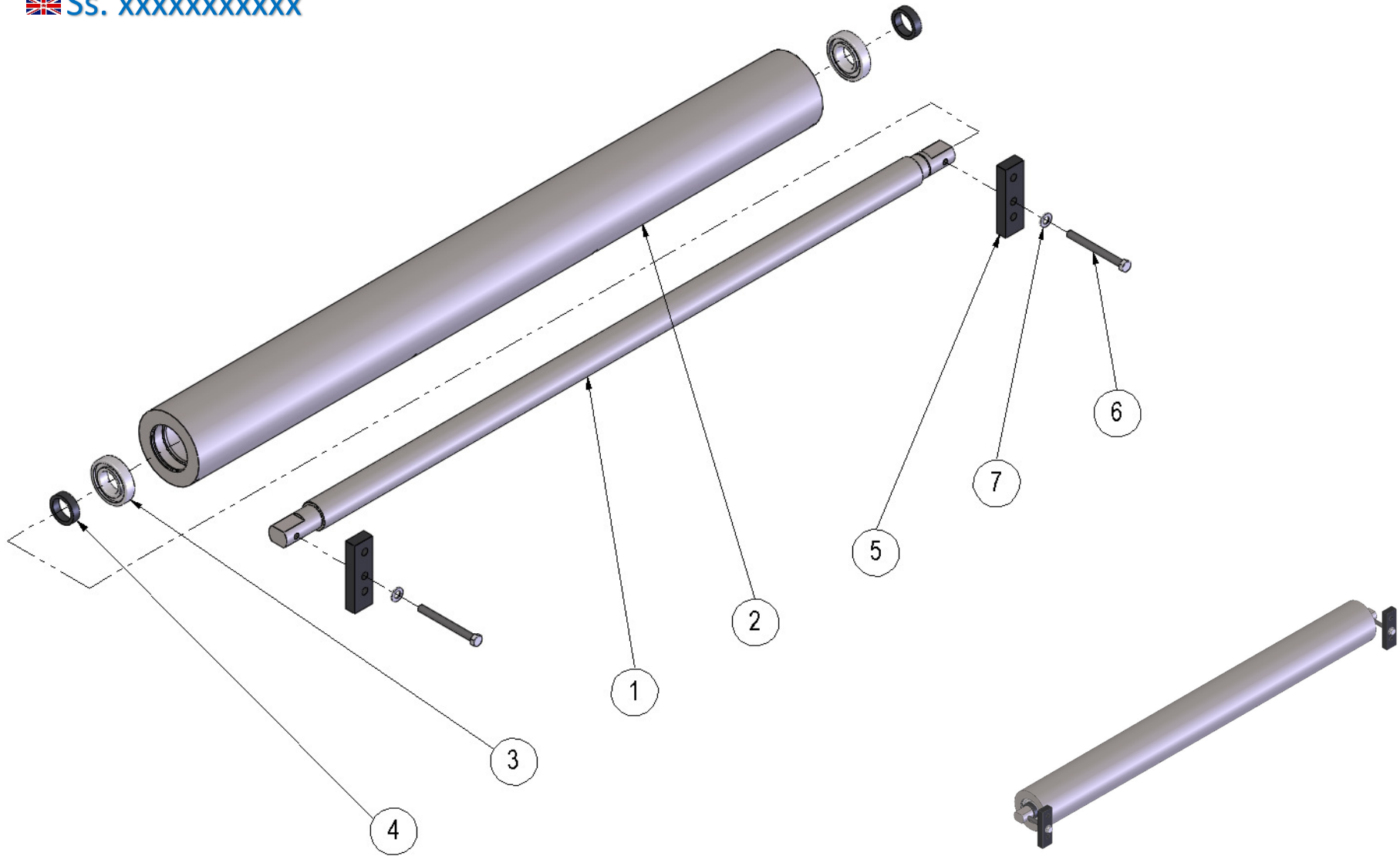

01	33254 (1X)	02	9372 (4X)	03	9373 (2X)	04	9374 (4X)	05	9375 (8X)
									
06	9378 (4X)	07	11488 (2X)	08	11483 (1X)	09	11327 (1X)	10	9385 (1X)
									
11	9389 (1X)	12	19070 (1X)	13	18959 (1X)	14	3710 (1X)	15	20132 (1X)
									
16	71394 (1X)								
									

# 🇧🇷 Sc. Rolo Esticador – 11483

🇪🇸 Sc. xxxxxxxxxxxx

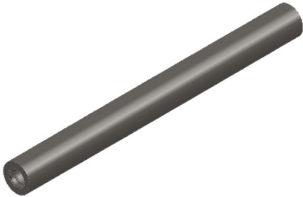
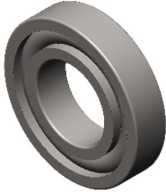
🇬🇧 Ss. xxxxxxxxxxxx



01	9376 (1X)	02	9377 (1X)	03	4947 (2X)	04	9379 (2X)	05	9381 (2X)
									
06	6337 (2X)	07	3417 (2X)						
									

# 🇧🇷 Sc. Rolo de Tração – 11327

🇪🇸 Sc. xxxxxxxxx

🇬🇧 Ss. xxxxxxxxx

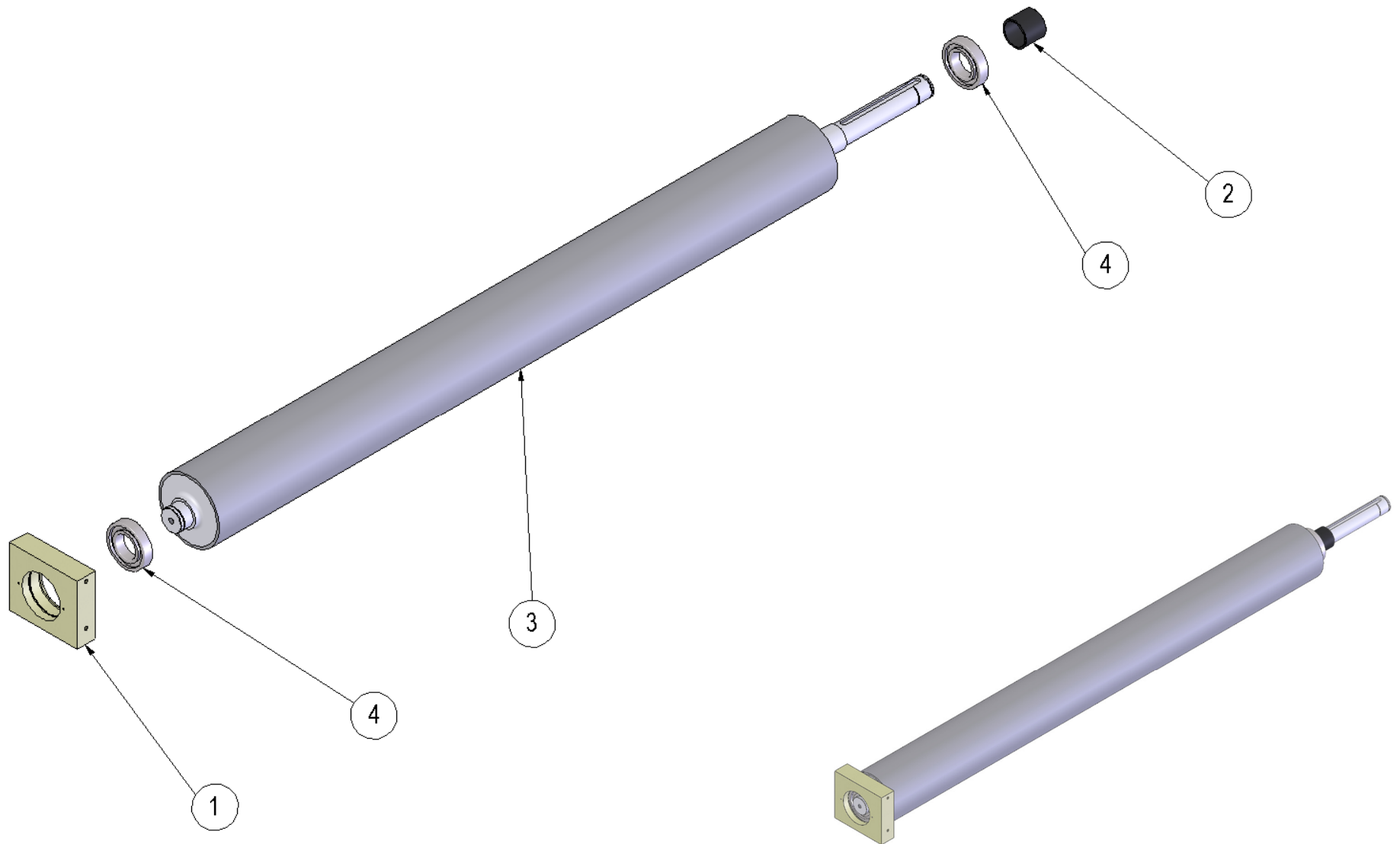

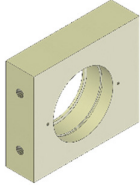
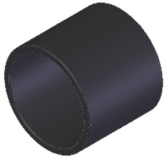
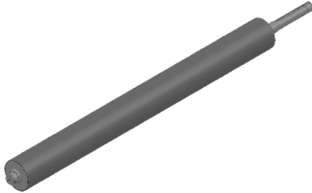
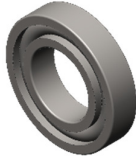
01	9382 (1X)	02	9383 (1X)	03	28 (1X)	04	849 (2X)
							







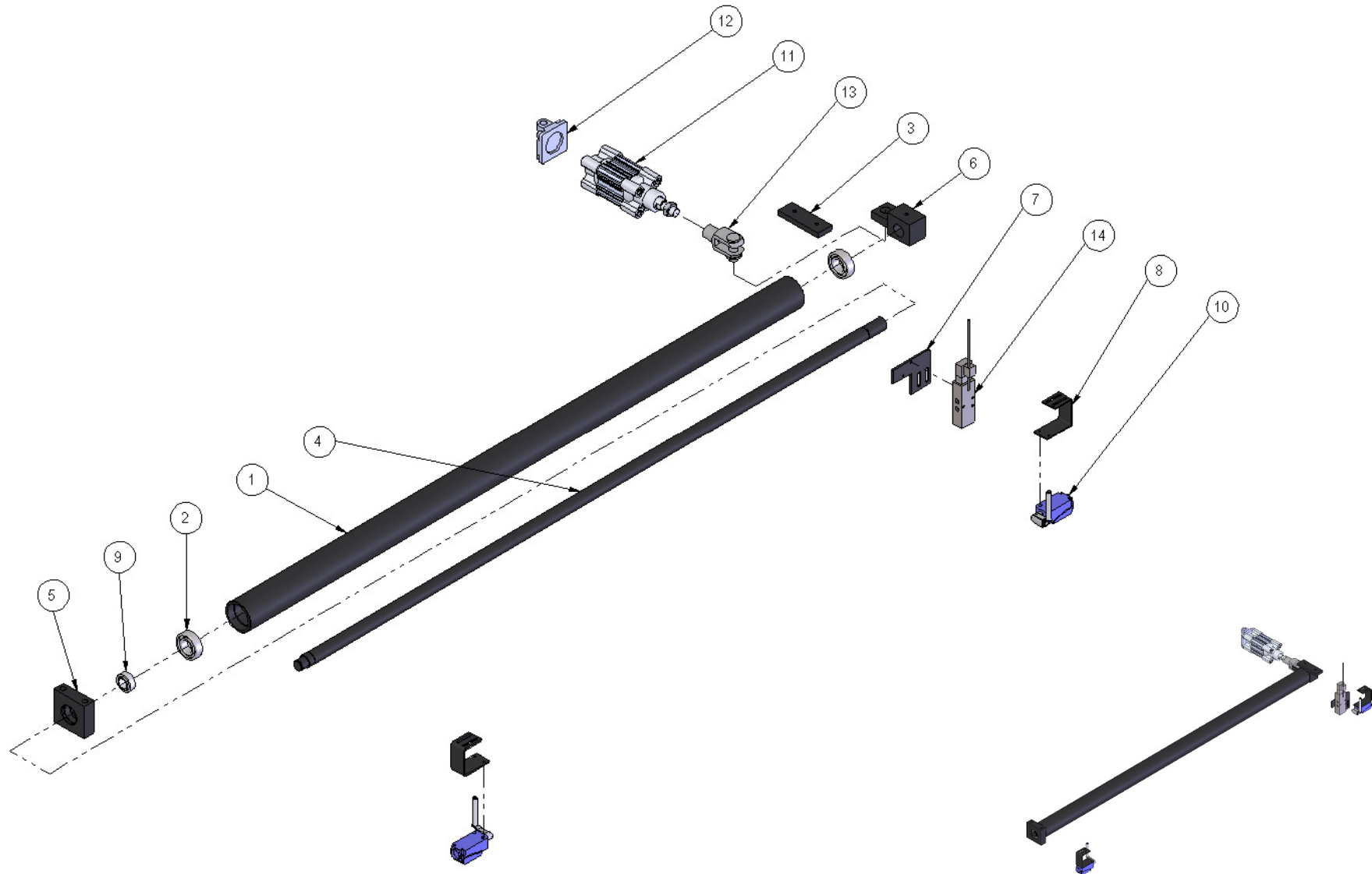

# 🇧🇷 Gr. Centragem Automatica – 11339

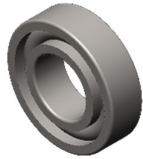
🇪🇸 Gr. xxxxxxxxxxxxxx

🇬🇧 Gr. xxxxxxxxxxxxxx

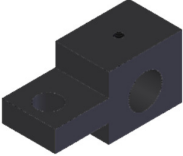

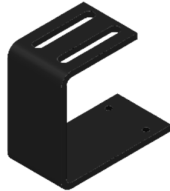
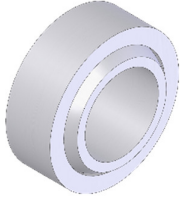
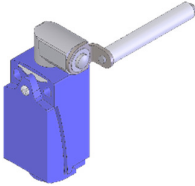
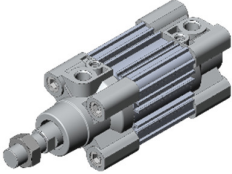
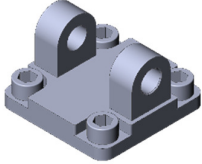
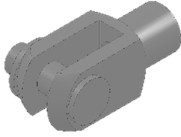









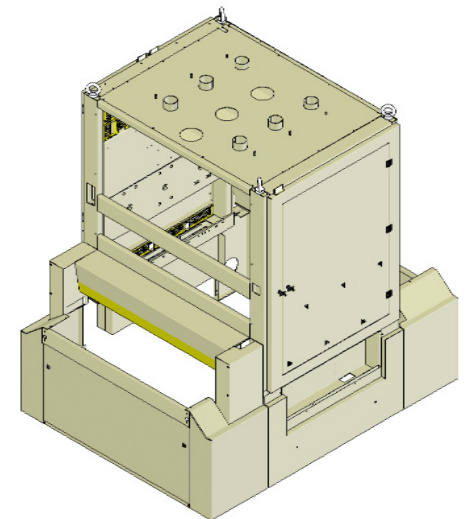
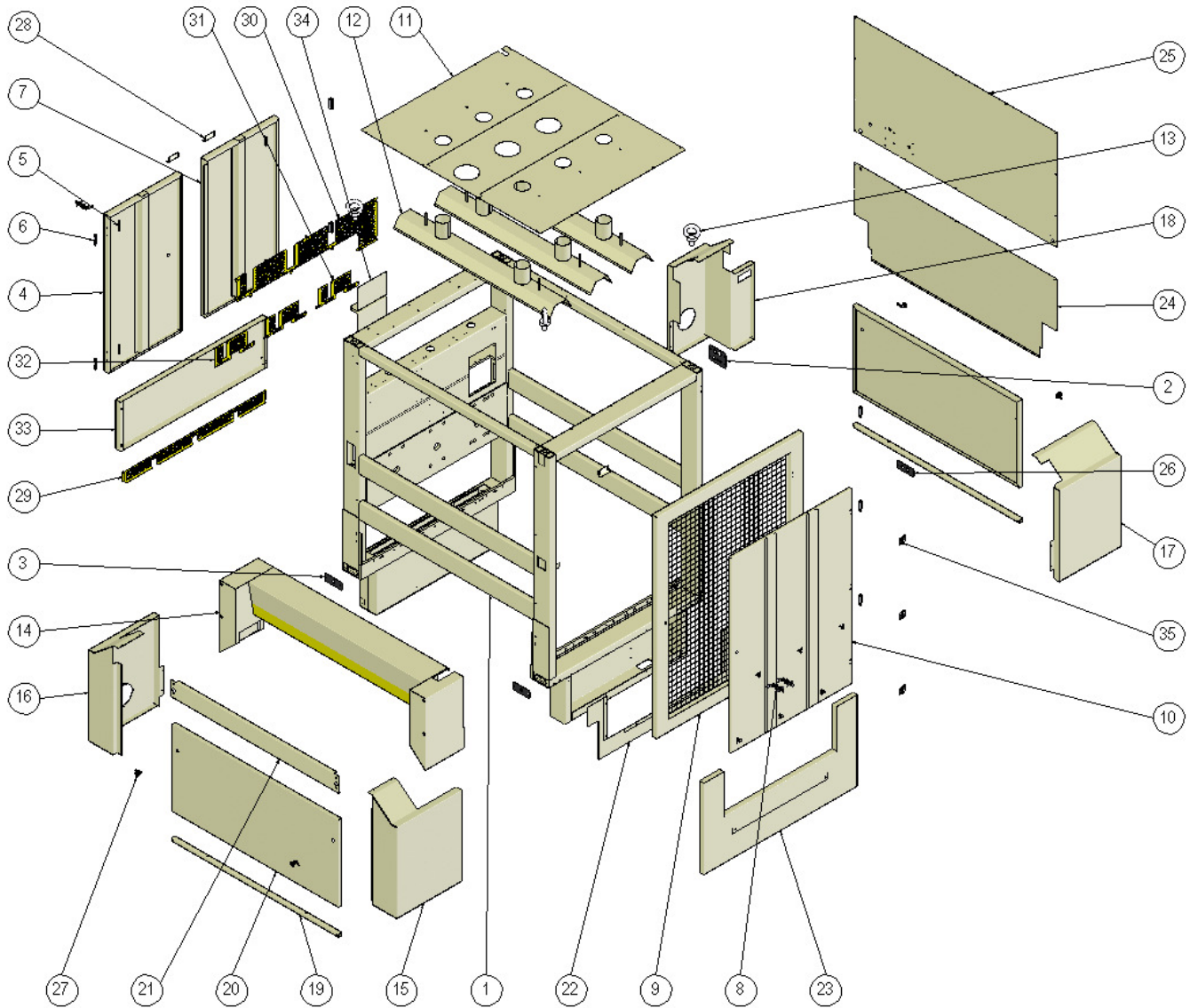

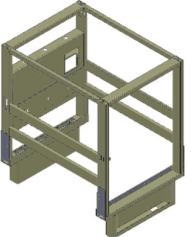
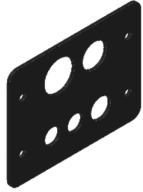

01	9505 (1X)	02	5101 (2X)	03	9507 (1X)	04	9508 (1X)	05	9509 (1X)
									
06	9510 (1X)	07	9511 (1X)	08	66100 (2X)	09	65804 (1X)	10	83709 (2X)
									
11	1839 (1X)	12	31772 (1X)	13	8187 (1X)	14	51171 (1X)		
									

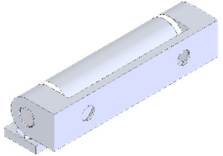

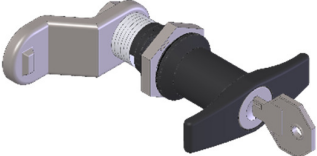
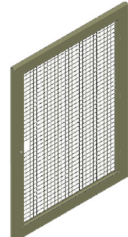
# 🇧🇷 Gr. Estrutura 3 Grupos– 17946

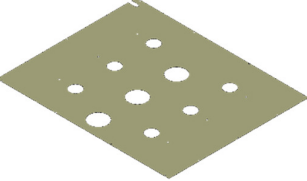
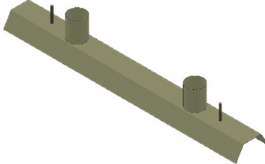
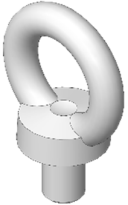
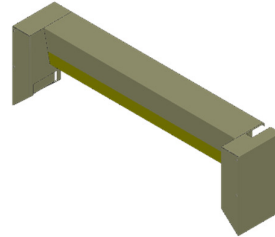
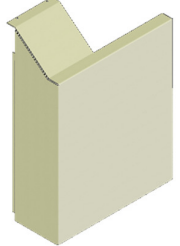
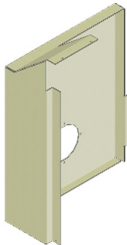
🇪🇸 Gr. XXXXXXXXXXXXX

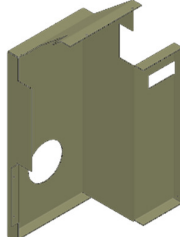
🇬🇧 Gr. XXXXXXXXXXXXX

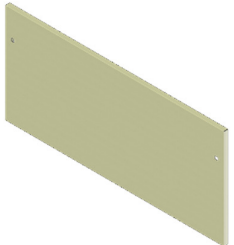

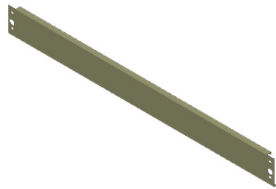
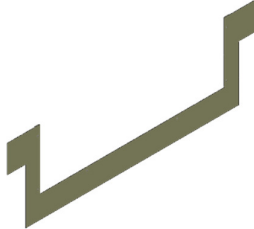
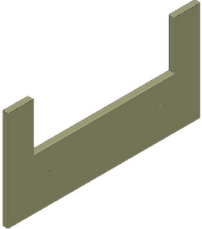
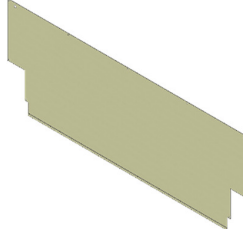
01	17733 (1x)	02	9092 (1x)	03	9093 (2x)	04	69895 (1x)	05	9079 (4x)
									
06	5053 (7x)	07	70133 (1x)	08	47191 (3x)	09	70070 (1x)	10	70072 (1x)
									
11	17949 (1x)	12	9350 (3x)	13	5506 (4x)	14	81363 (1x)	15	33674 (1x)
									
16	33675 (1x)	17	33676 (1x)	18	33677 (1x)	19	56818 (2x)	20	33687 (2x)
									

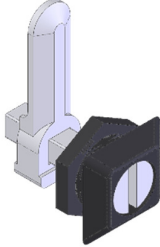
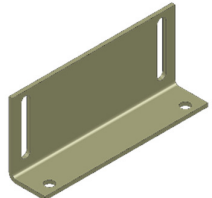
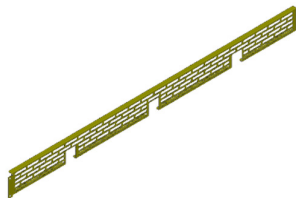
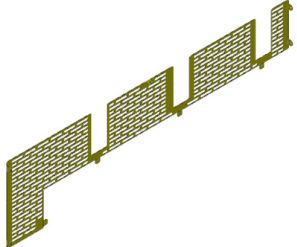
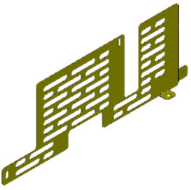
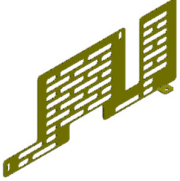
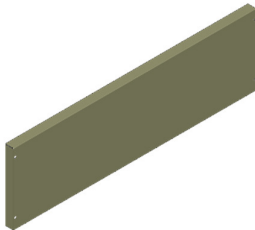
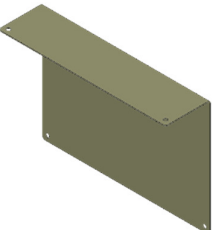
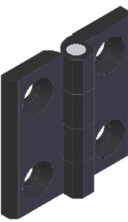







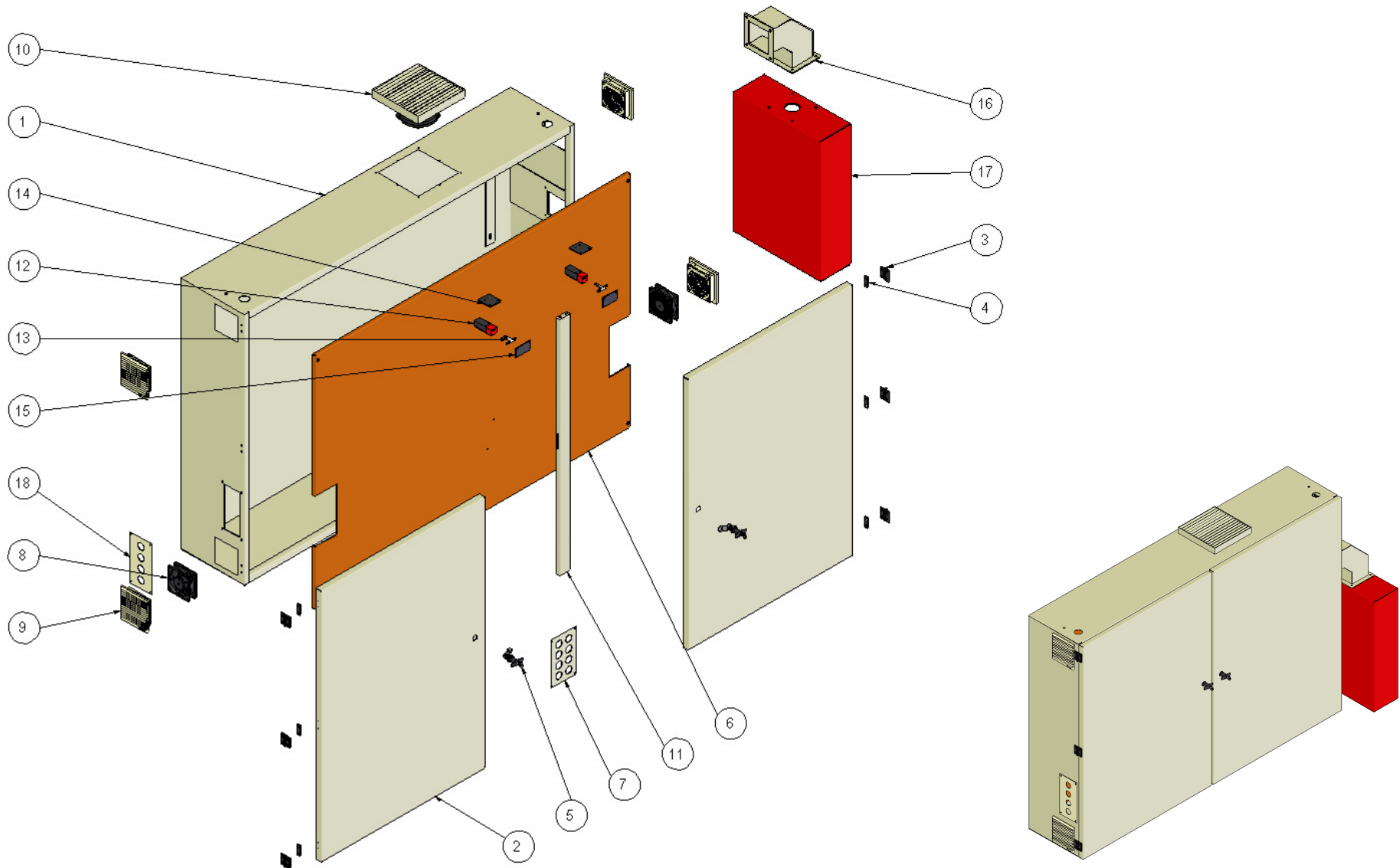

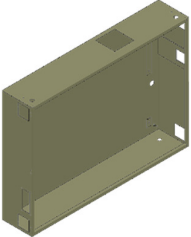

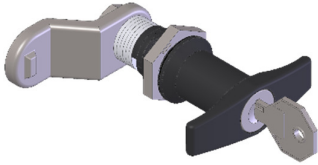
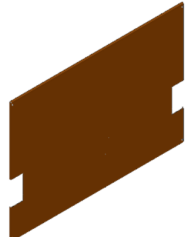

21	33673 (1x)	22	33689 (1x)	23	33690 (1x)	24	18224 (1x)	25	52701 (1x)	
										
26	7928 (4x)	27	82330 (3x)	28	70113 (1x)	29	70115 (1x)	30	70255 (2x)	
										
31	70270 (1x)	32	70107 (1x)	33	70001 (2x)	34				7954 (3x)
										

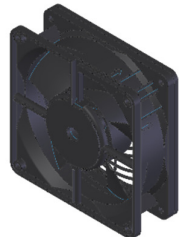
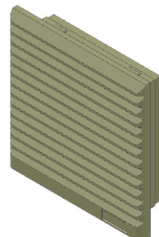
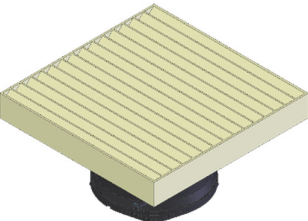
# 🇧🇷 Gr. Armário Elétrico – 82919

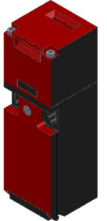
🇪🇸 Gr. XXXXXXXXXXXXX

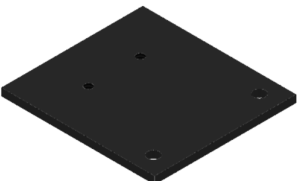
🇬🇧 Gr. XXXXXXXXXXXXX

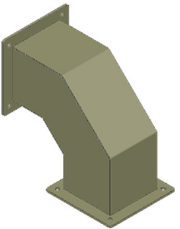
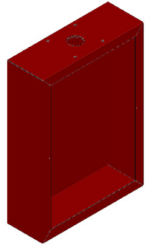

01	81355 (1x)	02	81362 (2x)	03	7954 (6x)	04	17146 (6x)	05	47191 (2x)
									
06	12031 (1x)	07	9447 (1x)	08	5048 (2x)	09	82925 (4x)	10	21503 (1x)
									
11	12032 (1x)	12	67312 (2x)	13	64951 (2x)	14	83753 (2x)	15	83754 (2x)
									
16	81314 (1x)	17	62140 (1x)	18	47149 (1x)				
									









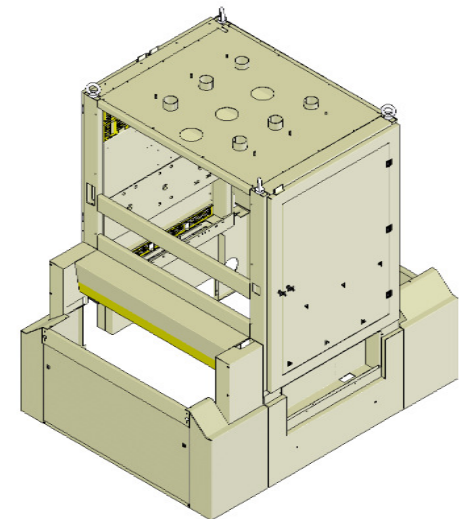
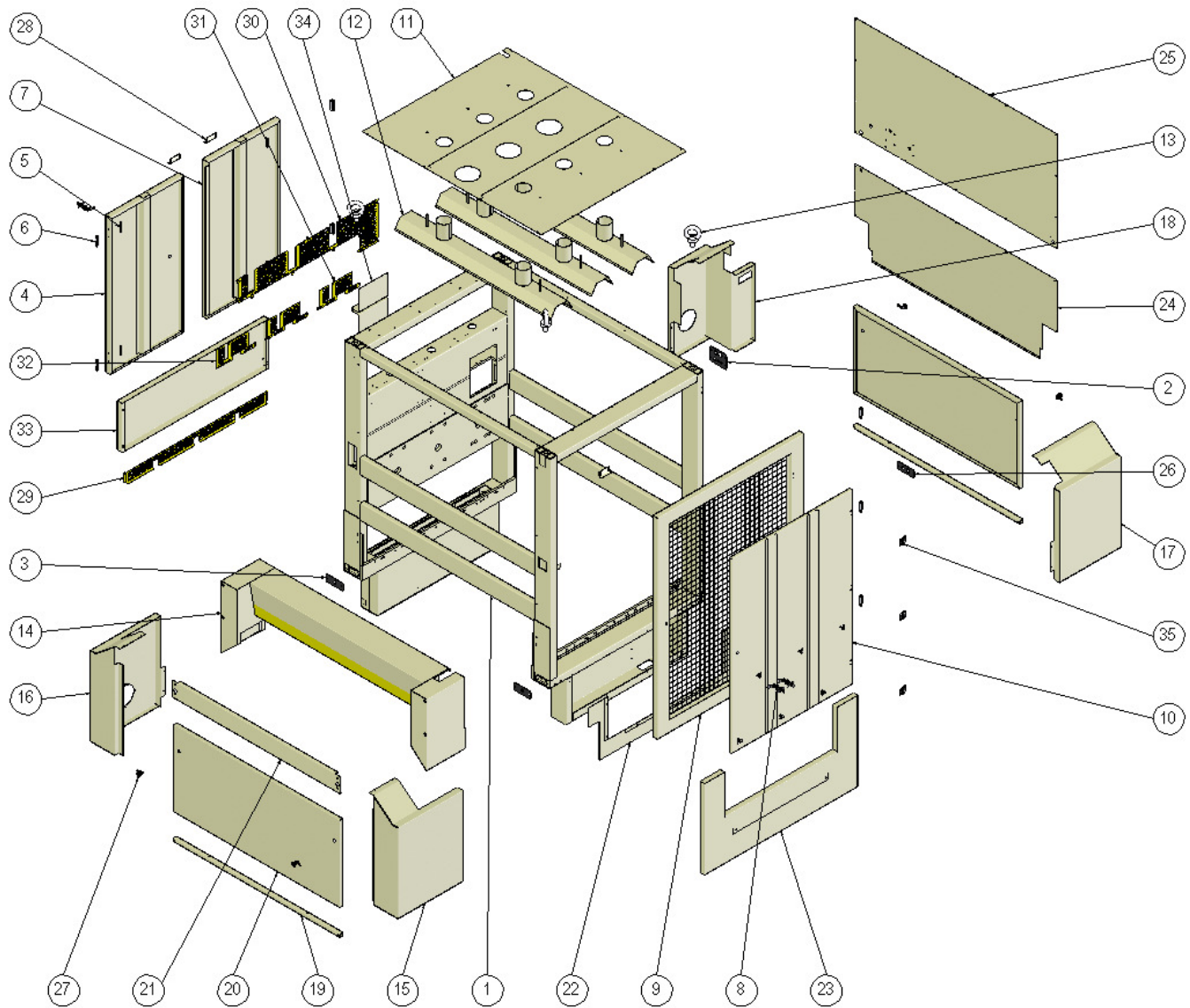

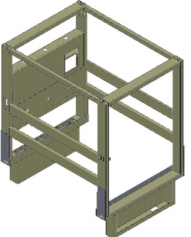

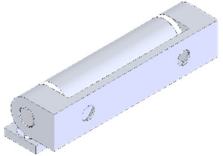

# 🇧🇷 Gr. Estrutura 3 Grupos– 17946

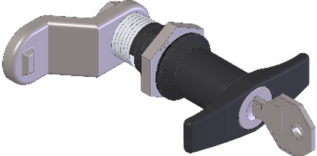
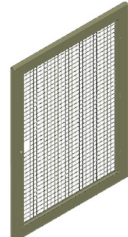
🇪🇸 Gr. XXXXXXXXXXXXX

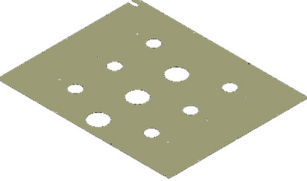
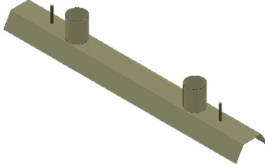
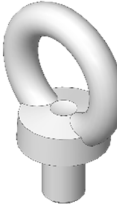
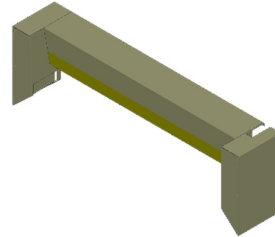
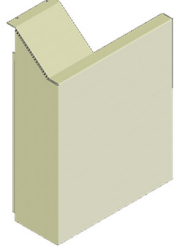
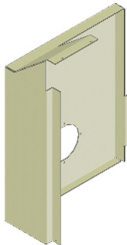
🇬🇧 Gr. XXXXXXXXXXXXX

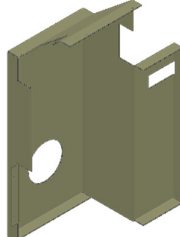

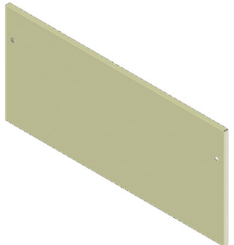
01	17733 (1x)	02	9092 (1x)	03	9093 (2x)	04	69895 (1x)	05	9079 (4x)
									
06	5053 (7x)	07	70133 (1x)	08	47191 (3x)	09	70070 (1x)	10	70072 (1x)
									
11	17949 (1x)	12	9350 (3x)	13	5506 (4x)	14	81363 (1x)	15	33674 (1x)
									
16	33675 (1x)	17	33676 (1x)	18	33677 (1x)	19	56818 (2x)	20	33687 (2x)
									



maacLinea